

76×30 mm

San Ace B76 9BD type   



General Specifications

- Material Frame: Plastic (Flammability: UL 94V-0), Impeller: Plastic (Flammability: UL 94V-1)
- Expected life See the table below. (L10 life: 90% survival rate for continuous operation in free air at 60°C, rated voltage)
- Motor protection function Locked rotor burnout protection, Reverse polarity protection
For details, please refer to p. 547.
- Dielectric strength 50/60 Hz, 500 VAC, for 1 minute (between lead wire conductors and frame)
- Insulation resistance 10 MΩ or more with a 500 VDC megger (between lead wire conductors and frame)
- Sound pressure level (SPL) At 1 m away from the air inlet
- Storage temperature -30 to +70°C (Non-condensing)
- Lead wire ⊕Red ⊖Black or Blue (Sensor) Yellow
- Mass 100 g

Specifications

The models listed below **have pulse sensors**.

Model no.	Rated voltage [V]	Operating voltage range [V]	Rated current [A]	Rated input [W]	Rated speed [min ⁻¹]	Max. airflow [m ³ /min] [CFM]	Max. static pressure [Pa] [inchH ₂ O]	SPL [dB (A)]	Operating temperature [°C]	Expected life [h]
109BD12HC2	12	10.2 to 13.8	0.37	4.44	3000	0.36 12.7	151.9 0.61	41.5	-20 to +60	40000/60°C
109BD12FC2			0.27	3.24	2600	0.31 10.9	98 0.394	37		
109BD12MC2			0.14	1.68	2100	0.25 8.8	58.8 0.236	32.5		
109BD24HC2	24	20.4 to 27.6	0.17	4.08	3000	0.36 12.7	151.9 0.61	41.5	-20 to +60	
109BD24FC2			0.14	3.36	2600	0.31 10.9	98 0.394	37	-20 to +70	
109BD24MC2			0.1	2.4	2100	0.25 8.8	58.8 0.236	32.5	-20 to +70	

The following sensor and control options are available for selection.

Available for all models. **Without sensor** **Lock sensor**

Differs according to the model. Refer to the table on p. 561. **PWM control**

Airflow - Static Pressure Characteristics

109BD12HC2 With pulse sensor

Operating voltage range

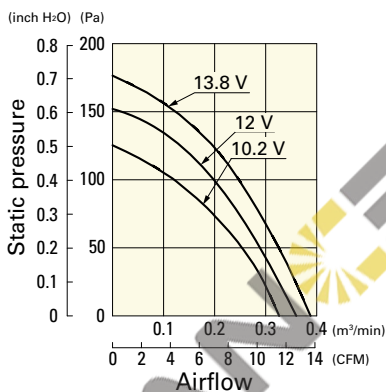

109BD12FC2 With pulse sensor

Operating voltage range

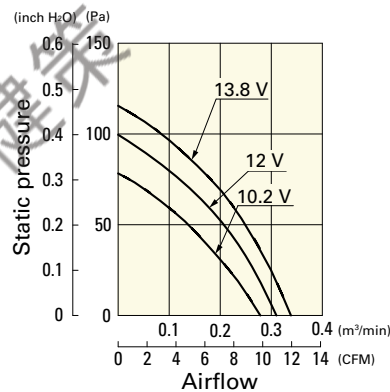

109BD12MC2 With pulse sensor

Operating voltage range

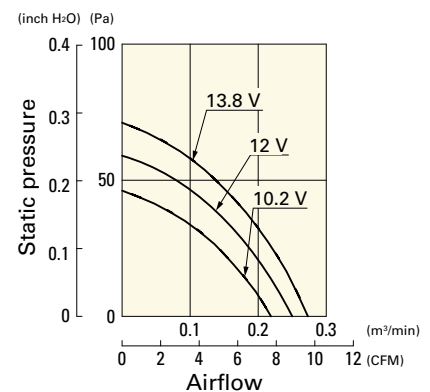

Airflow - Static Pressure Characteristics

109BD24HC2 With pulse sensor

Operating voltage range

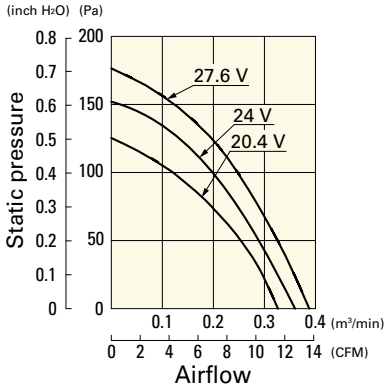

109BD24FC2 With pulse sensor

Operating voltage range

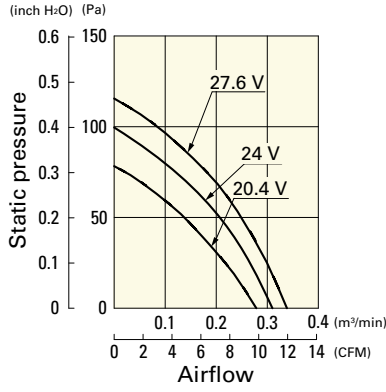

109BD24MC2 With pulse sensor

Operating voltage range

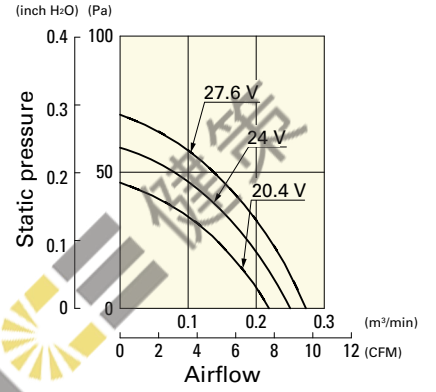

Dimensions (unit: mm)

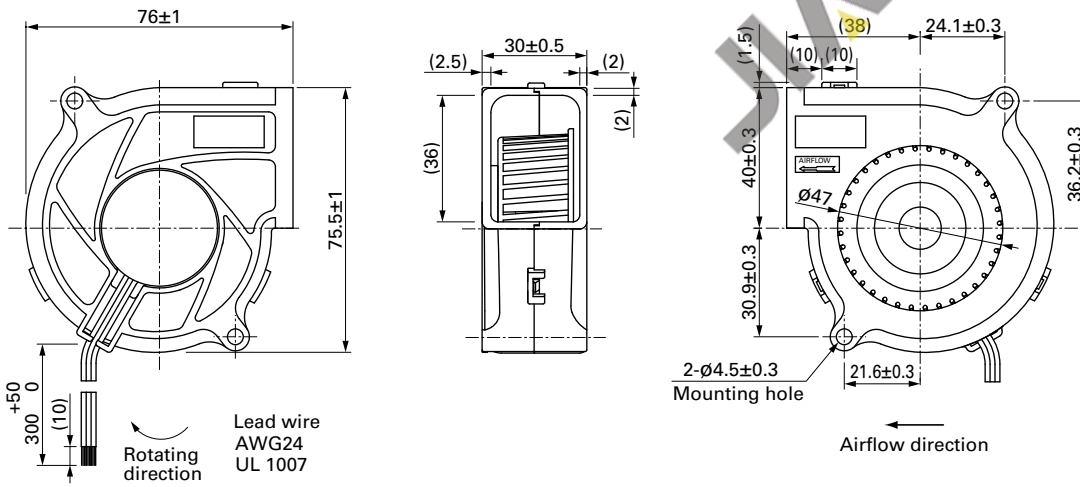

Blower 76 mm DC

JIAN 健策

JIAN 健策
0755—23706799



Mouser Electronics

Authorized Distributor

Click to View Pricing, Inventory, Delivery & Lifecycle Information:

Sanyo Denki:

[109BD12FA2](#) [109BD12FC2](#) [109BD12FD2](#) [109BD12HA2](#) [109BD12HC2](#) [109BD12HD2](#) [109BD12MA2](#)
[109BD12MC2](#) [109BD12MD2](#) [109BD24FA2](#) [109BD24FC2](#) [109BD24FD2](#) [109BD24HA2](#) [109BD24HC2](#) [109BD24HD2](#)
[109BD24MA2](#) [109BD24MC2](#) [109BD24MD2](#) [109BD12P2H01](#)

JIAN 健策

JIAN 健策
0755—23706799

